

PHILIPS

Fully automatic
espresso machine

800 series
1200 series
2200 series
3200 series

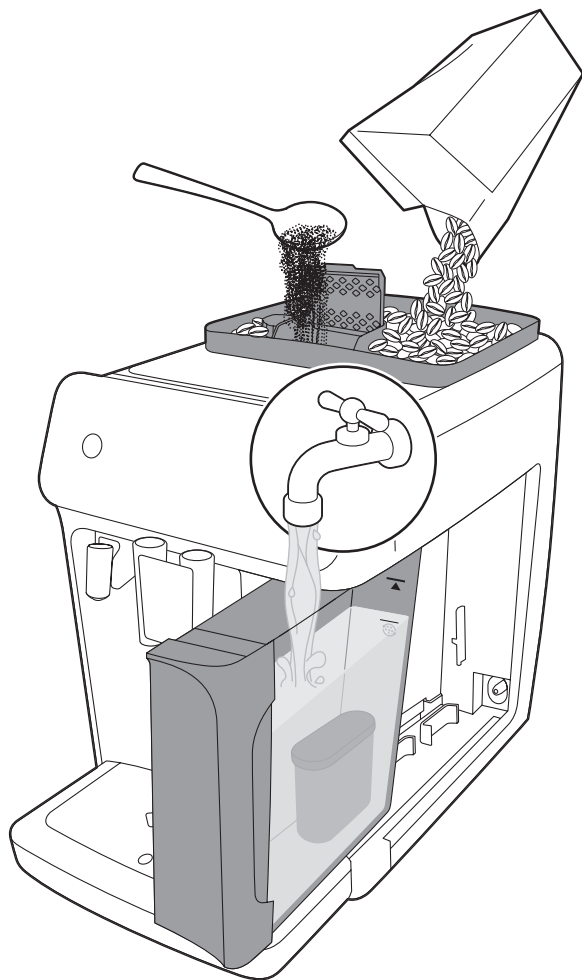



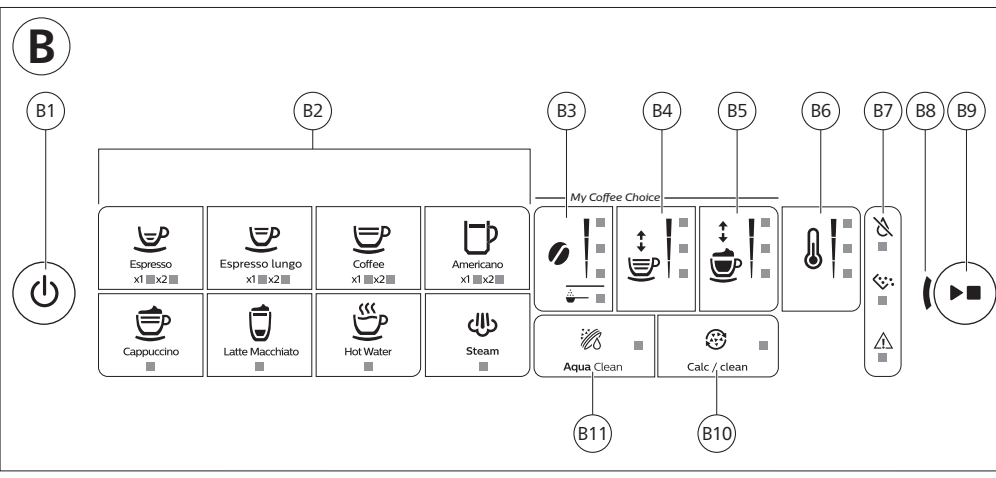
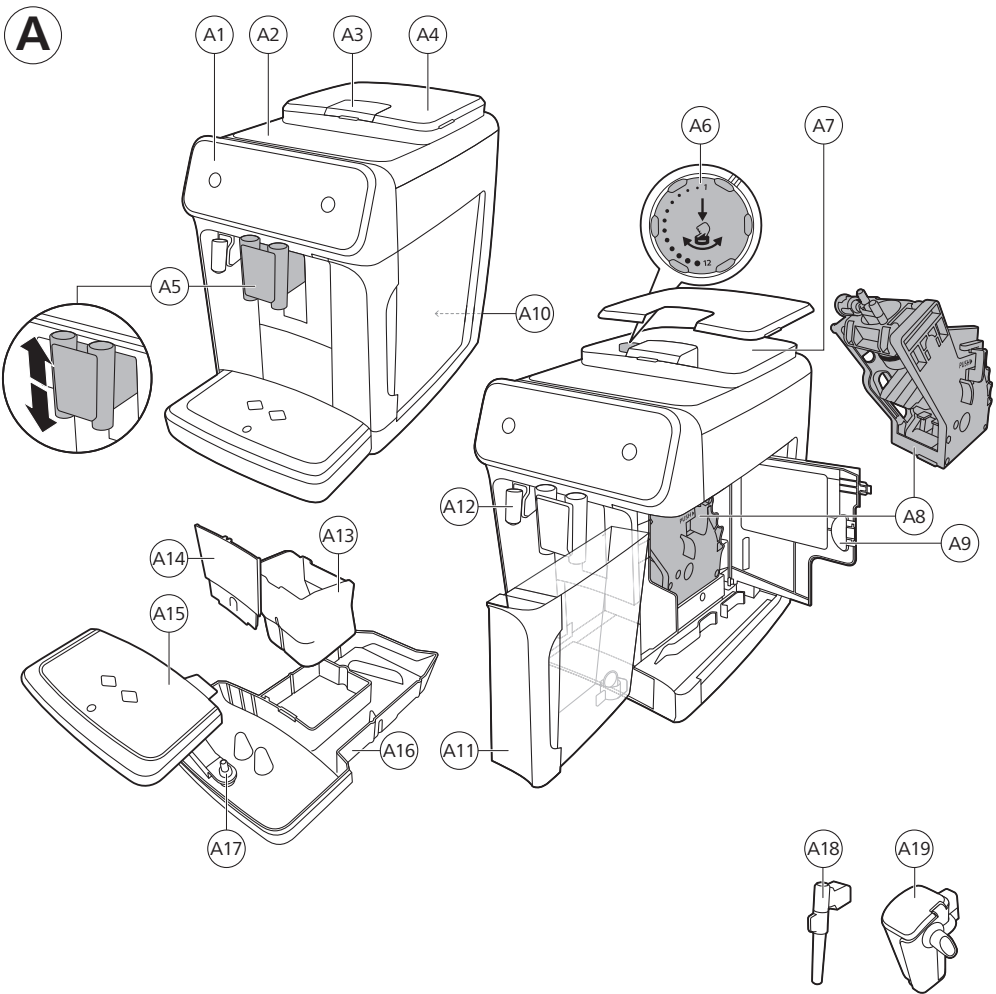

EN USER MANUAL
简体中文 用户手册

















C

<p>800 series 1200 series 2200 series 3200 series</p>	<p>A18 </p>	<p>A19 </p>
<p>Classic Milk Frother</p> <p>EP0810 EP0820 EP0824 EP1220 EP1221 EP1222 EP1223 EP1224 EP2124 EP2220 EP2221 EP2223 EP2224 EP2225 EP3221 EP3226</p> 	<p>✓</p>	<p>✗</p>
<p>LatteGo</p> <p>EP2230 EP2231 EP2232 EP2235 EP2236 EP3241 EP3242 EP3243 EP3246 EP3249</p> 	<p>✗</p>	<p>✓</p>

D

				
 <p>A17</p>	 <p>A16</p>	 <p>A15</p>	 <p>A13</p>	 <p>A18</p>
 <p>A19</p>				

			
 <p>A14</p>	 <p>A8</p>	 <p>A4</p>	 <p>A11</p>

Contents

Machine overview (Fig. A)	4
Control panel (Fig. B)	4
Introduction	5
Before first use	6
Brewing drinks	7
Adjusting machine settings	9
Removing and inserting the brew group	11
Cleaning and maintenance	11
AquaClean water filter	14
Setting the water hardness	15
Descaling procedure (30 min.)	15
Ordering accessories	17
Troubleshooting	17
Technical specifications	22

Machine overview (Fig. A)

A1	Control panel	A10	Data label with type number
A2	Cup holder	A11	Water tank
A3	Pre-ground coffee compartment	A12	Hot water spout
A4	Lid of bean hopper	A13	Coffee grounds container
A5	Adjustable coffee spout	A14	Front panel of coffee grounds container
A6	Grind setting knob	A15	Drip tray cover
A7	Coffee bean hopper	A16	Drip tray
A8	Brew group	A17	'Drip tray full' indicator
A9	Service door		

Accessories

A18	Classic milk frother (specific types only)	A19	LatteGo (milk container) (specific types only)
-----	--	-----	--

Control panel (Fig. B)

Refer to figure B for an overview of all buttons and icons. Below you find the description.

i Some of the buttons/icons are for specific types only.

B1	On/off button	B7	Warning icons
B2	Drink icons*	B8	Start light
B3	Aroma strength/pre-ground coffee icon	B9	Start/stop ► button
B4	Drink quantity icon	B10	Calc / Clean icon
B5	Milk quantity icon (specific types only)	B11	AquaClean icon
B6	Coffee temperature icon (specific types only)		

* Drink icons: espresso, espresso lungo, coffee, (caffè) americano, cappuccino, latte macchiato, hot water, caffè latte, steam (specific types only)

Introduction

Congratulations on your purchase of Philips fully automatic coffee machine! To fully benefit from the support that we offer, please follow up our WeChat official account and download Philips HomeCare+ APP via below QR codes.



WeChat



Philips HomeCare+

Read the separate safety booklet carefully before you use the machine for the first time and save it for future reference.

Before first use, rinse with hot water all removable accessories destined to come into contact with water or milk. To help you get started and to get the best out of your machine, we offer support in multiple ways. In the box you can find:

- 1 The quick start guide with picture-based usage instructions and information on cleaning and maintenance.
- 2 The separate safety booklet with instructions on how to use the machine in a safe way.
- 3 For online support (this extended user manual, frequently asked questions, videos, etc.), scan the QR code on the cover of this booklet to download Philips HomeCare+ APP.

i There are multiple versions of this espresso machine, which all have different features. Each version has its own type number. You can find the type number on the rating label on the back of the machine (see Fig. A10).

i This machine has been tested with coffee. Although it has been carefully cleaned, there may be some coffee residues left. We guarantee, however, that the machine is absolutely new.

The machine automatically adjusts the amount of ground coffee that is used to make the best-tasting coffee. You should brew 5 coffees initially to allow the machine to complete its self-adjustment. Make sure you rinse the LatteGo (milk container) or the classic milk frother before first use.

Before first use

1. Setting up the machine

After you have switched on the machine, some water may be dispensed from the hot water spout or coffee spout. This is normal.

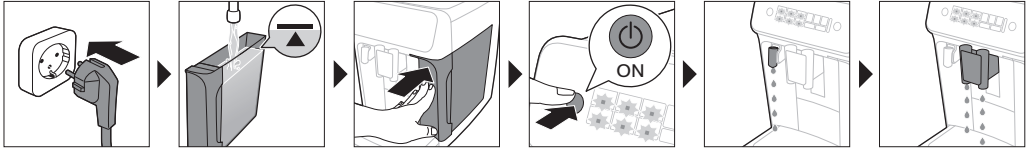

2. Activating the AquaClean water filter (5 min.)

i AquaClean water filter is not by-packed in all models: you can buy it through our online retailers and in physical stores. *Availability varies per country.

For more information see chapter 'AquaClean water filter'.

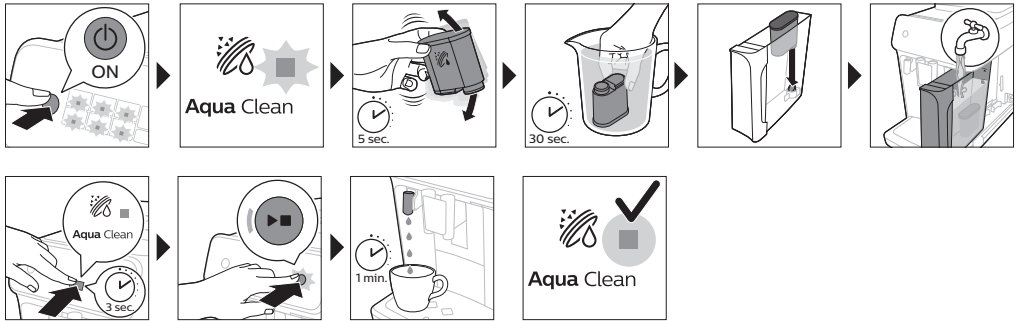

3. Setting the water hardness

See chapter 'Setting the water hardness' for step-by-step instructions. The default water hardness setting is 4: hard water.

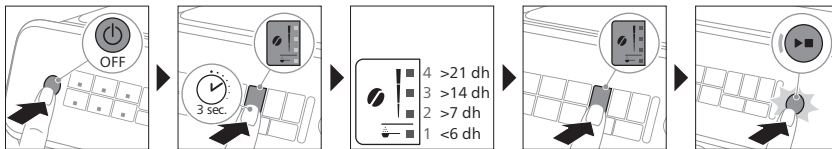

4. Assembling LatteGo (specific types only)

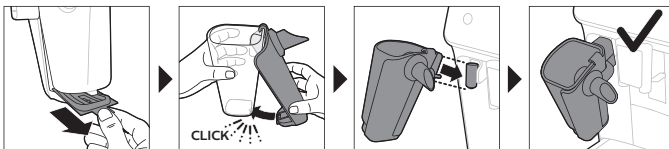

5. Assembling the classic milk frother (specific types only)

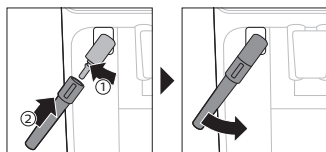

Brewing drinks

General steps

- 1 Fill the water tank with tap water and fill the bean hopper with beans.
- 2 Press the on/off button to switch on the machine.
 - The machine starts heating up and performs the automatic rinsing cycle. During heating up, the lights in the drinks icons light up and go out slowly one by one.
 - When all lights in the drink icons light up continuously, the machine is ready for use.
- 3 Place a cup under the coffee dispensing spout. Slide the coffee dispensing spout up or down to adjust its height to the size of the cup or glass you are using (Fig. 1).

Personalizing drinks

This machine allows you to adjust the settings of a drink to your own preference. After selecting a drink you can:

- 1 Adjust the aroma strength by tapping the aroma strength icon (Fig. 2). There are 3 strengths, the lowest is the mildest and the highest is the strongest.
- 2 Adjust the drink quantity by tapping the drink quantity (Fig. 3) and/or the milk quantity icon (specific types only). There are 3 quantities: low, medium and high.

i You can also adjust the coffee temperature to your own preference (see 'Adjusting the coffee temperature').

Brewing coffee with beans

- 1 To brew a coffee, tap the drink icon of your choice.
 - The aroma strength and quantity lights go on and show the previously selected setting.
 - You can now adjust the drink to your preferred taste (see 'Personalizing drinks').
- 2 Press the start/stop ►■ button.
 - The light in the drink icon flashes while the drink is being dispensed.

i Specific types only: A (caffè) americano is made of espresso and water. When you brew an americano, the machine first dispenses an espresso and then water.

- 3 To stop dispensing coffee before the machine is finished, press the start/stop ►■ button again.

i To brew 2 coffees at the same time, tap the drink icon twice. The 2x light lights up.

Brewing milk-based drinks with LatteGo (milk container)

⚠ LatteGo consists of a milk container, a frame and a storage lid. To avoid leakage, make sure the frame and the milk container are properly assembled before you fill the milk container.

8 English

- 1 To assemble LatteGo, first insert the top of the milk container under the hook at the top of the frame (Fig. 4). Then press home the bottom part of the milk container. You hear a click when it locks into place (Fig. 5).

Note: Make sure that the milk container and the frame are clean before you connect them.

- 2 Slightly tilt LatteGo and put it on the hot water spout (Fig. 6). Then press it home until it locks into place (Fig. 7).
- 3 Fill LatteGo with milk up to the level indicated on the milk container for the drink you are brewing (Fig. 8). Do not fill the milk container beyond the maximum indication.

i If you have personalized the milk quantity, you may need to fill the milk container with more or less milk than indicated for this drink on LatteGo.

☞ Always use milk coming directly from the fridge for optimal results.

- 4 Place a cup on the drip tray.
- 5 Tap the milk-based drink icon of your choice.
 - You can now adjust the drink to your own preference (see 'Personalizing drinks').
- 6 Press the start/stop **▶■** button.
 - The light in the drink icon flashes while the drink is being dispensed. When you brew a cappuccino or latte macchiato, the machine first dispenses milk and then coffee.
 - To stop dispensing milk before the machine has dispensed the preset amount, press the start/stop **▶■** button.
- 7 To stop dispensing the complete drink (milk and coffee) before the machine is finished, press and hold the start/stop **▶■** button.

Frothing milk with classic milk frother

☞ Always use milk coming directly from the fridge for the best foam quality.

- 1 Tilt the black silicone handle on the machine to the left and slide the milk frother onto it (Fig. 9).
- 2 Fill a milk jug with with approx. 100 ml milk for cappuccino and approx. 150 ml milk for latte macchiato.
- 3 Insert the milk frother approx. 1 cm into the milk.
- 4 Tap the steam icon (Fig. 10).
 - The light in the steam icon goes on and the start light starts pulsing.
- 5 Press the start/stop **▶■** button to froth the milk (Fig. 11).
 - The machine starts heating up, steam is forced into the milk and the milk is frothed.
- 6 When the milk foam in the milk jug has reached the required volume, press the start/stop **▶■** button again to stop frothing milk.

i Never froth milk longer than 90 seconds. The frothing automatically stops after 90 seconds.

i You do not have to move the milk jug during milk frothing to get the best milk froth quality.

Brewing coffee with pre-ground coffee

You can choose to use pre-ground coffee instead of beans, for example if you prefer a different coffee variety or decaffeinated coffee.

- 1 Press the on/off button to switch on the machine and wait until it is ready for use.
- 2 Open the lid of the pre-ground coffee compartment and pour 3 tea spoons of coffee powder (about 8 g) into it (Fig. 12). Then close the lid.
- 3 Place a cup under the coffee dispensing spout.

- 4 Select a single drink.
- 5 Press the aroma strength icon for 3 seconds (Fig. 13).
 - The pre-ground coffee light goes on and the start light starts pulsing.
- 6 Press the start/stop ►■ button.
- 7 To stop dispensing coffee before the machine is finished, press the start/stop ►■ button again.

i With pre-ground coffee you can only brew one coffee at a time.

i Pre-ground coffee is not a setting that is saved as a previous selected strength setting. Each time you want to use pre-ground coffee, you need to press the aroma strength icon for 3 seconds.

i When you select pre-ground coffee, you cannot select a different aroma strength.

Dispensing hot water

- 1 If attached, remove LatteGo or the milk frother.
- 2 Tap the hot water icon (Fig. 14).
 - The drink quantity lights go on and show the previous selected drink setting for hot water.
- 3 Adjust the hot water quantity to your preference by tapping the drink quantity icon (Fig. 3).
- 4 Press the start/stop ►■ button.
 - The light in the hot water icon flashes and hot water is dispensed from the hot water spout (Fig. 15).
- 5 To stop dispensing hot water before the machine is finished, press the start/stop ►■ button again.

Adjusting machine settings

Adjusting the stand-by time

- 1 Press the on/off button to switch off the machine.
- 2 When the machine is switched off: press and hold the Calc / Clean icon (Fig. 16) until the Calc / Clean light and the Aroma strength lights go on (Fig. 17).
- 3 Tap the Aroma strength icon to select the required stand-by time: 15, 30, 60 or 180 minutes. Respectively 1, 2, 3 or 4 lights of the Aroma strength icon light up.
- 4 When you have finished setting the stand-by time, press the start/stop button. The machine switches off.
- 5 Press the on/off button to switch on the machine again.

Programming the highest default setting of your drinks

The machine has 3 default settings for each drink: low, medium, high. You can only adjust the quantity of the highest setting. The new quantity can be stored as soon as the start light starts to pulse.

i Before you start programming the quantity of a milk drink, assemble LatteGo and pour milk in it.

- 1 To adjust the highest quantity setting, press and hold the icon of the drink you want to adjust for 3 seconds.
 - The upper light of the drinks quantity icon and the upper light of the milk quantity icon (specific types only) starts to pulse and the start/stop ►■ button starts to pulse, indicating that you are in programming mode.
- 2 Press the start/stop ►■ button. The machine starts to brew the selected beverage.

10 English

- The start light lights up continuously at first. When the machine is ready to store the adjusted volume, the start/stop light starts to pulse.

- 3 Press the start/stop ► button again when the cup contains the desired quantity of coffee or milk.
 - In case of cappuccino or latte macchiato, first the milk will be dispensed. In case of caffè latte, first the coffee will be dispensed. Press the start/stop ► button when the cup contains the desired milk quantity (or coffee in case of caffè latte). The machine automatically starts dispensing the coffee (or milk in case of caffè latte). Press the start/stop ► button again when the cup contains the desired quantity.

After you have programmed the new highest default quantity for a drink, the machine will dispense this new amount each time you select the highest quantity of this drink.

i You can only adjust the highest default quantity level.

i If you want to go back to the default quantity settings, see 'Restoring factory settings'.

Adjusting the coffee temperature

Machines without temperature icon

- 1 Press the on/off button to **switch off** the machine.
- 2 When the machine is switched off: press and hold the coffee quantity icon until the lights in this icon go on (Fig. 18).
- 3 Tap the quantity icon to select the required temperature: normal, high or max.
 - Respectively 1, 2 or 3 lights are on.
- 4 When you have finished setting the coffee temperature, press the start/stop ► button.
- 5 Press the on/off button to switch on the machine again.

i If you do not switch off the machine yourself, it will switch off automatically after some time.

Machines with temperature icon (EP3221 only)

- 1 Tap the coffee temperature icon repeatedly to select the desired temperature.

Restoring factory settings

The machine offers you the possibility to restore the drinks default settings at any moment.

i You can only restore the default settings when the machine is switched off.

- 1 Press the on/off button to switch the machine off.
- 2 Press and hold the espresso icon for 3 seconds.
 - The middle lights in the drink setting icons light up. The start/stop light starts to pulse, indicating that the settings are ready to be restored.
- 3 Press the start/stop ► button to confirm you want to restore the settings.
- 4 Press the on/off button to switch on the machine again.

Adjusting grinder settings

You can change the coffee strength with the grind setting knob inside the bean container. The lower the grind setting, the finer the coffee beans are ground and the stronger the coffee. There are 12 different grind settings you can choose from.

The machine has been set up to get the best taste out of your coffee beans. Therefore we advise you not to adjust the grind setting until you have brewed 100-150 cups (approx. 1 month of use).

i You can only adjust the grind settings when the machine is grinding coffee beans. You need to brew 2 to 3 drinks before you can taste the full difference.

A Do not turn the grind setting knob more than one notch at a time to prevent damage to the grinder.

- 1 Place a cup under the coffee dispensing spout.
- 2 Open the lid of the coffee bean hopper.
- 3 Tap the espresso icon and then press the start/stop ►■ button.
- 4 When the grinder starts grinding, press down the grind setting knob and turn it to the left or right. (Fig. 19)

Removing and inserting the brew group

Go to Philips HomeCare+ APP for detailed video instructions on how to remove, insert and clean the brew group.

Removing the brew group from the machine

- 1 Switch off the machine.
- 2 Remove the water tank and open the service door (Fig. 20).
- 3 Press the PUSH handle (Fig. 21) and pull at the grip of the brew group to remove it from the machine (Fig. 22).

Reinserting the brew group

A Before you slide the brew group back into the machine, make sure it is in the correct position.

- 1 Check if the brew group is in the correct position. The arrow on the yellow cylinder on the side of the brew group has to be aligned with the black arrow and N (Fig. 23).
 - If they are not aligned, push down the lever until it is in contact with the base of the brew group (Fig. 24).
- 2 Slide the brew group back into the machine along the guiding rails on the sides (Fig. 25) until it locks into position with a click (Fig. 26). Do not press the PUSH button.
- 3 Close the service door and place back the water tank.

Cleaning and maintenance

Regular cleaning and maintenance keeps your machine in top condition and ensures good-tasting coffee for a long time with a steady coffee flow.

Consult the table below for a detailed description on when and how to clean all detachable parts of the machine. You can find more detailed information and video instructions via Philips HomeCare+ APP. See figure D for an overview of which parts can be cleaned in the dishwasher.

Detachable parts	When to clean	How to clean
Brew group	Weekly	Remove the brew group from the machine (see 'Removing and inserting the brew group'). Rinse it under the tap (see 'Cleaning the brew group under the tap').

Detachable parts	When to clean	How to clean
	Monthly	Clean the brew group with the Philips coffee oil remover tablet (see 'Cleaning the brew group with the coffee oil remover tablets').
Classic milk frother	After every use	First dispense hot water with the milk frother attached to the machine for thorough cleaning. Then remove the milk frother from the machine and disassemble it. Clean all parts under the tap or in the dishwasher.
Pre-ground coffee compartment	Check the pre-ground coffee compartment weekly to see if it is clogged.	Unplug the machine and remove the brew group. Open the lid of the pre-ground coffee compartment and insert the spoon handle into it. Move the handle up and down until the clogged ground coffee falls down (Fig. 27). Scan the QR code to download the Philips HomeCare+ APP for detailed video instructions.
Coffee grounds container	Empty the coffee grounds container when prompted by the machine. Clean it weekly.	Remove the coffee grounds container while the machine is switched on. Rinse it under the tap with some washing-up liquid or clean it in the dishwasher. The front panel of the coffee grounds container is not dishwasher-safe.
Drip tray	Empty the drip tray daily or as soon as the red 'drip tray full' indicator pops up through the drip tray (Fig. 28). Clean the drip tray weekly.	Remove the drip tray (Fig. 29) and rinse it under the tap with some washing-up liquid. You can also clean the drip tray in the dishwasher. The front panel of the coffee grounds container (fig. A14) is not dishwasher-safe.
LatteGo	After every use	Rinse LatteGo under the tap or clean it in the dishwasher.
Lubrication of the brew group	Every 2 months	Consult the lubrication table and lubricate the brew group with the Philips grease (see 'Lubricating the brew group').
Water tank	Weekly	Rinse the water tank under the tap.

Cleaning the brew group

Regular cleaning of the brew group prevents coffee residues from clogging up the internal circuits. Find support videos via Philips HomeCare+ APP on how to remove, insert and clean the brew group.

Cleaning the brew group under the tap

- 1 Remove the brew group (see 'Removing and inserting the brew group').
- 2 Rinse the brew group thoroughly with water. Carefully clean the upper filter (Fig. 30) of the brew group.
- 3 Let the brew group air-dry before you place it back. Do not dry the brew group with a cloth to prevent fibers from collecting inside the brew group.

Cleaning the brew group with the coffee oil remover tablets

Only use Philips coffee oil remover tablets.

- 1 Put a cup under the coffee spout. Fill the water tank with fresh water.

- 2 Put a coffee oil remover tablet in the pre-ground coffee compartment.
- 3 Tap the coffee icon and then press the aroma strength icon for 3 seconds to select the pre-ground coffee function (Fig. 2).
- 4 Do not add pre-ground coffee. Press the the start/stop ► button to start the brewing cycle. When half a cup of water has been brewed, unplug the machine.
- 5 Let the coffee oil remover solution act for at least 15 minutes.
- 6 Insert the mains plug back into a wall socket and switch on the machine to complete the brewing cycle. Empty the cup.
- 7 Remove the water tank and open the service door. Remove the brew group (see 'Removing the brew group from the machine') and rinse it thoroughly under the tap.
- 8 Reinsert the brew group and water tank and place a cup under the coffee spout.
- 9 Tap the coffee icon and then press the aroma strength icon for 3 seconds to select the pre-ground coffee function (Fig. 2). Do not add pre-ground coffee. Press the start/stop ► button to start the brewing cycle. Repeat this twice. Empty the cup.

Lubricating the brew group

Lubricate the brew group every 2 months, to ensure that the moving parts continue to move smoothly.

- 1 Apply a thin layer of grease on the piston (grey part) of the brew group (Fig. 31).
- 2 Apply a thin layer of grease around the shaft (yellow part) in the bottom of the brew group (Fig. 32).
- 3 Apply a thin layer of grease to the rails on both sides (Fig. 33).

Cleaning LatteGo (milk container)

Cleaning LatteGo after every use

- 1 Remove LatteGo from the machine (Fig. 34).
- 2 Pour out any remaining milk.
- 3 Press the release button and remove the milk container from the frame of LatteGo (Fig. 35).
- 4 Clean all parts in the dishwasher or under the tap with lukewarm water and some washing-up liquid.

Cleaning the classic milk frother

Cleaning the classic milk frother after every use

Clean the milk frother each time you use it for hygiene reasons and to avoid the build-up of milk residues.

- 1 Place a cup under the milk frother.
- 2 Tap the steam icon and then press the start/stop ► button to start dispensing steam and to remove any milk that may be left inside the milk frother.
- 3 To stop dispensing steam after a few seconds, press the start/stop ► button again.
- 4 Clean the milk frother with a damp cloth.

Daily cleaning of the classic milk frother

- 1 Let the milk frother cool down completely.
- 2 Tilt the milk frother to the left (Fig. 36) and remove both the metal part and the silicone part (Fig. 37).
- 3 Disassemble the two parts (Fig. 38) and rinse them with fresh water or clean them in the dishwasher. Make sure that the small hole on the metal tube (Fig. 39) is completely clean and not clogged by milk residues.
- 4 Reassemble the two milk frother parts and reattach the milk frother to the machine.

AquaClean water filter

Your machine is AquaClean enabled. You can place the AquaClean water filter in the water tank to preserve the taste of your coffee. It also diminishes the need for descaling by reducing limescale build-up in your machine. You can buy an AquaClean water filter through our online retailers and in physical stores. For any questions, please call the Philips Home Appliances official service hotline: 4008-203-160.

i *Availability varies per country.

AquaClean icon and light

Your machine is equipped with an AquaClean water filter light (Fig. 40) to indicate the status of the filter. Use the table below to see what actions are required when the light is on or when it is flashing.



When you use the machine for the first time, the AquaClean light starts flashing orange. This indicates that you can start using the AquaClean water filter. If you do not activate an AquaClean water filter, the light will switch off automatically after a while.



Once you have installed the filter and activated it with the AquaClean icon, the AquaClean light turns blue to confirm that the AquaClean water filter is active.



When the filter is exhausted, the AquaClean light starts flashing orange again to remind you to replace the filter with a new one.



When the orange AquaClean light is off, you can still activate an AquaClean filter, you will need to descale the machine first.

Activating the AquaClean water filter (5 min.)

i The machine does not automatically detect that a filter has been placed in the water tank. Therefore you need to activate each new AquaClean water filter that you install with the AquaClean icon.

When the orange AquaClean light is off, you can still activate an AquaClean water filter, but you will need to descale the machine first.

i Your machine has to be completely limescale-free before you start to use the AquaClean water filter.

Before activating the AquaClean water filter, it has to be prepared by soaking it in water as described below. If you don't do this, air might be drawn into the machine instead of water, which makes a lot of noise and prevents the machine from being able to brew coffee.

- 1 Make sure that the machine is switched on.
- 2 Shake the filter for about 5 seconds (Fig. 41).
- 3 Immerse the filter upside down in a jug with cold water and shake/press it (Fig. 42).
- 4 The filter is now prepared for use and can be inserted into the water tank.
- 5 Insert the filter vertically onto the filter connection in the water tank. Press it down to the lowest possible point (Fig. 43).
- 6 Fill the water tank with fresh water and place it back into the machine.
- 7 If attached, remove the LatteGo.
- 8 Place a bowl under the hot water spout/milk frother.
- 9 Press the AquaClean icon for 3 seconds (Fig. 44). The start light starts to pulse.
- 10 Press the start/stop ► button to start the activation process.
- 11 Hot water will be dispensed from the hot water spout/milk frother (3 min.).

12 When the activation process is finished, the blue AquaClean light goes on to confirm that the AquaClean water filter has been activated correctly.

Replacing the AquaClean water filter (5 min.)

After 95 liters of water have flowed through the filter, the filter will cease to work. The AquaClean light turns orange and starts to flash to remind you to replace the filter. As long as it flashes, you can replace the filter without having to descale the machine first. If you do not replace the AquaClean water filter, the orange light will go out eventually. In that case you can still replace the filter but you first need to descale the machine.

When the orange AquaClean light flashes:

- 1 Take out the old AquaClean water filter.
- 2 Install a new filter and activate it as described in chapter 'Activating the AquaClean water filter (5 min.)'.

i Replace the AquaClean water filter at least every 3 months, even if the machine does not yet indicate that replacement is required.

Setting the water hardness

i We advise you to adjust the water hardness to the water hardness in your region for optimal performance and a longer lifetime of the machine. This also prevents you from having to descale the machine too often. The default water hardness setting is 4: hard water.

Set the machine to the correct water hardness:

- 1 Press the on/off button to **switch off** the machine.
- 2 When the machine is switched off, tap and hold the aroma strength icon until all lights in the icon go on (Fig. 2).
- 3 Tap the aroma strength icon 1, 2, 3 or 4 times. The number of lights that are on should be the same as the number of the water hardness table.
- 4 When you have set the correct water hardness, press the start/stop ►■ button.

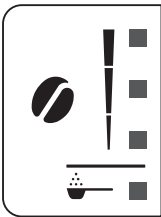
	4	4 red dots	>21 dh
	3	3 red dots	>14 dh
	2	2 red dots	>7 dh
	1	1 red dot or 4 green dots	<6 dh

i Since you only set the water hardness once, the aroma strength function is used to select the water hardness. This does not affect the aroma strength of the drinks you make afterwards.

Descaling procedure (30 min.)

To clean and descale the machine, we recommend to use the Philips maintenance products if available in your country. Under no circumstances should you use a descaler based on sulfuric acid, hydrochloric acid, sulfamic or acetic acid (vinegar) as this may damage the water circuit in your machine and not dissolve the limescale properly. Failure to descale the appliance will also void your warranty. You can buy a Philips

16 English

descaler through our online retailers and in physical stores. For any questions, please call the Philips Home Appliances official service hotline: 4008-203-160.

When the Calc / Clean light switches on, you need to descale the machine.

- 1 Make sure that the machine is switched on.
- 2 If attached remove LatteGo or milk frother.
- 3 Remove the drip tray and the coffee grounds container, empty them and put them back into place.
- 4 Remove the water tank and empty it. Then remove the AquaClean water filter.
- 5 Pour the whole bottle of Philips descaler in the water tank and then fill it with water up to the Calc / Clean indication (Fig. 45). Then place it back into the machine.
- 6 Place a large container (1.5 l) under the coffee dispensing spout and the water spout.
- 7 Press the Calc / Clean icon for 3 sec. and then press the start/stop ► button.
- 8 The first phase of the descaling procedure starts. The descaling procedure lasts approx. 30 minutes and consists of a descaling cycle and a rinsing cycle. During the descaling cycle the Calc / Clean light flashes to show that the descaling phase is in progress.
- 9 Let the machine dispense the descaling solution until the display reminds you that the water tank is empty.
- 10 Empty the water tank, rinse it and then refill it with fresh water up to the Calc / Clean indication.
- 11 Empty the container and place it back under the coffee dispensing spout and the water spout. Press the start/stop ► button again.
- 12 The second phase of the descaling cycle, the rinsing phase, starts and lasts 3 minutes. During this phase the lights on the control panel go on and off to show that the rinsing phase is in progress.
- 13 Wait until the machine stops dispensing water. The descaling procedure is finished when the machine stops dispensing water.
- 14 The machine will now heat up again. When the lights in the drink icons light up continuously, the machine is ready for use again.
- 15 Install and activate a new AquaClean water filter in the water tank (see 'Activating the AquaClean water filter (5 min.)').
 - When the descaling procedure is finished, the AquaClean light flashes for a while to remind you to install a new AquaClean water filter.

 Tip: Using the AquaClean filter reduces the need for descaling!

What to do if the descaling procedure is interrupted

You can exit the descaling procedure by pressing the on/off button on the control panel. If the descaling procedure is interrupted before it is completely finished, do the following:

- 1 Empty and rinse the water tank thoroughly.
- 2 Fill the water tank with fresh water up to the Calc / Clean level indication and switch the machine back on. The machine will heat up and perform an automatic rinsing cycle.
- 3 Before brewing any drinks, perform a manual rinsing cycle. To perform a manual rinsing cycle, first dispense half a water tank of hot water by repeatedly tapping the hot water icon (Fig. 14) and then brew 2 cups of pre-ground coffee without adding ground coffee.

i If the descaling procedure was not completed, the machine will require another descaling procedure as soon as possible.

Ordering accessories

To clean and descale the machine, we advise you to use the maintenance products such as Philips descaling solution, Philips AquaClean water filter and coffee oil remover tablets. These products can be purchased from our online retailers and in physical stores. For any questions, please call the Philips Home Appliances official service hotline: 4008-203-160. You can find the model number on the rating label on the back of the machine.

i Brita-filters are not compatible with this machine.

Troubleshooting

This chapter summarizes the most common problems you could encounter with the machine. For support, download the Philips HomeCare+ APP through your app store, or by scanning the QR code on the cover of this booklet. Support videos and a complete list of frequently asked questions are available on www.philips.com/support. If you are unable to solve the problem, contact the Consumer Care Center in your country.

Warning icons

Warning icon

Solution



The 'water tank empty' light is on

- The water tank is almost empty. Fill the water tank with fresh water to the maximum level indication.
- The water tank is not in place. Place back the water tank.



The 'empty coffee grounds container' light is on

- The coffee grounds container is full. Remove and empty the coffee grounds container while the machine is switched on. Wait at least 5 seconds before you reinsert the container.



The alarm light is on

- The coffee grounds container and/or the drip tray is not in place or not placed correctly. Place back the coffee grounds container and/or the drip tray and make sure they are in the correct position.
- The service door is open. Remove the water tank and make sure the service door is closed.



The alarm light is flashing

- The brew group is not in place or not placed correctly. Remove the brew group and make sure it is locked into place. See chapter 'Removing and inserting the brew group' for step-by-step instructions.
- The brew group is blocked. Remove the brew group and rinse it with water under the tap. Then lubricate the brew group and place it back into the machine. See chapter 'Cleaning and maintenance' for step-by-step instructions.

Warning icon**Solution**

The alarm light is on and the start light flashes.

Some air is trapped inside the machine. To release the air from the machine, fill the water tank with water, place a cup under the classic milk frother and press the flashing start/stop button.

Be careful: small jets of hot water will be dispensed from the classic milk frother to release the air.



Aqua Clean

AquaClean light is flashing: place or replace the AquaClean water filter and activate it. See chapter 'AquaClean water filter' for step-by-step instructions.



Calc / clean

Descaling light is flashing slowly: Descale the machine.



The lights in the drink icons light up and go out one by one.

The machine is heating up and/or trying to release the air that was drawn into the machine. Wait until all drink lights light up continuously.



The lights of all warning icons are flashing.

Reset the machine by unplugging it and plugging it back in. Before switching the machine back on, follow these steps:



- Remove the AquaClean water filter from the water tank.



- Place back the water tank. Push it into the machine as far as possible to make sure it is in the right position.



- Open the lid of the pre-ground coffee compartment and check if this is clogged with coffee powder. To clean it, insert a spoon handle into the pre-ground coffee compartment and move the handle up and down until the clogged ground coffee falls down (Fig. 27). Remove the brew group and remove all ground coffee that has fallen down. Place back the clean brew group.

- Switch the machine back on.

If the problem is solved the AquaClean filter was not prepared well. Prepare the AquaClean filter before placing it back by following steps 1 and 2 in chapter 'Activating the AquaClean water filter (5 min)'.
If the lights continue to flash, the machine could be overheated. Switch the machine off, wait 30 minutes and switch it on again. If the lights are still flashing, contact the Consumer Care Center in your country. For contact details, see the international warranty leaflet.

Troubleshooting table

This chapter summarizes the most common problems you could encounter with the machine. Support videos and a complete list of frequently asked questions are available on www.philips.com/support. If you are unable to solve the problem, contact the Consumer Care Center in your country. For contact details, see the warranty leaflet.

Problem	Cause	Solution
The drip tray fills up quickly.	This is normal. The machine uses water to rinse the internal circuit and brew group. Some water flows through the internal system directly into the drip tray.	Empty the drip tray daily or as soon as the red 'drip tray full' indicator pops up through the drip tray cover. Tip: place a cup under the dispensing spout to collect rinsing water that comes out of it.
The 'empty coffee grounds container' light remains on.	You emptied the coffee grounds container while the machine was switched off.	Always empty the coffee grounds container while the machine is switched on. Remove the coffee grounds container, wait at least 5 sec. and then insert it again.
The machine prompts to empty the coffee grounds container even though the container is not full.	The machine did not reset the counter the last time you emptied the coffee grounds container.	Always wait approx. 5 seconds when you place back the coffee grounds container. In this way the coffee grounds counter will be reset to zero.
The coffee grounds container is too full and the 'empty coffee grounds container' light did not go on.	You removed the drip tray without emptying the grounds container.	Always empty the coffee grounds container while the machine is switched on. If you empty the coffee grounds container when the machine is switched off, the coffee grounds counter won't reset.
I cannot remove the brew group.	The brew group is not in the correct position.	When you remove the drip tray, also empty the coffee grounds container even if it contains only a few coffee pucks. In this way the coffee grounds counter will be reset to zero, re-starting to correctly count the coffee pucks. Reset the machine in the following way: close the service door and place back the water tank. Switch the machine off and back on again. Try again to remove the brew group. See chapter 'Removing and inserting the brew group' for step by step instructions.
I cannot insert the brew group.	The brew group is not in the correct position.	Reset the machine in the following way: close the service door and place back the water tank. Leave the brew group out. Switch the machine off and unplug it. Wait for 30 sec. and then plug the machine back in and switch it on. Then put the brew group in the correct position and reinsert it into the machine. See chapter 'Removing and inserting the brew group' for step by step instructions.
The coffee is watery.	The brew group is dirty or needs to be lubricated.	Remove the brew group (see 'Removing the brew group from the machine'), rinse it under the tap and leave it to dry. Then lubricate the moving parts (see 'Lubricating the brew group').

Problem	Cause	Solution
	The machine is performing its self-adjustment procedure. This procedure is started automatically when you use the machine for the first time, when you change to another type of coffee beans or after a long period of non-use.	Brew 5 cups of coffee initially to allow the machine to complete its self-adjustment procedure.
	The grinder is set to a too coarse setting.	Set the grinder to a finer (lower) setting. Brew 2 to 3 drinks to taste the full difference.
The coffee is not hot enough.	The temperature is set too low.	Set the temperature to the maximum (see 'Adjusting the coffee temperature').
	A cold cup reduces the temperature of the drink.	Preheat the cups by rinsing them with hot water.
	Adding milk reduces the temperature of the drink.	Regardless of whether you add hot or cold milk, adding milk always reduces the temperature of the coffee. Preheat the cups by rinsing them with hot water.
Coffee does not come out or coffee comes out slowly.	The AquaClean water filter was not prepared properly for installation.	Remove the AquaClean water filter and try to brew a coffee again. If this works, make sure that you have prepared the AquaClean water filter properly before you place it back. See chapter 'AquaClean water filter' for step-by-step instructions.
		After a long period of non-use, you need to prepare the AquaClean water filter for use again and then place it back. See step 1 - 3 of chapter 'Activating the AquaClean water filter'.
	The AquaClean water filter is clogged.	Replace the AquaClean water filter every 3 months. A filter that is older than 3 months can become clogged.
	The grinder is set to a too fine setting.	Set the grinder to a coarser (higher) setting. Note that this will impact the coffee taste.
	The brew group is dirty.	Remove the brew group and rinse it under the tap (see 'Cleaning the brew group under the tap').
	The coffee dispensing spout is dirty.	Clean the coffee dispensing spout and its holes with a pipe cleaner or needle.

Problem	Cause	Solution
	The pre-ground coffee compartment is clogged	Switch off the machine and remove the brew group. Open the lid of the pre-ground coffee compartment and insert the spoon handle into it. Move the handle up and down until the clogged ground coffee falls down (Fig. 27).
	The machine circuit is blocked by limescale.	Descale the machine. Always descale the machine when the descaling light starts to flash.
The machine grinds the coffee beans, but coffee does not come out.	The pre-ground coffee compartment is clogged.	Switch off the machine and remove the brew group. Open the lid of the pre-ground coffee compartment and insert the spoon handle into it. Move the handle up and down until the clogged ground coffee falls down (Fig. 27).
The milk does not froth.	Machines with LatteGo: LatteGo is incorrectly assembled.	Make sure that the milk container is properly assembled to the frame of LatteGo ('click').
	Machines with LatteGo: the milk container and/or frame of LatteGo are dirty.	Disassemble LatteGo and rinse both parts under the tap or clean them in the dishwasher (see 'Cleaning LatteGo after every use').
	Machines with classic milk frother: the milk frother is dirty.	Thoroughly clean the milk frother (see 'Cleaning the classic milk frother').
	The type of milk used is not suitable for frothing.	Different types of milk result in different amounts of froth and different froth qualities. We have tested the following milk types which proved to deliver a good milk froth result: semi-skimmed or full-fat cow's milk and lactose-free milk.
Milk is leaking from the bottom of the LatteGo milk container.	The frame and the milk container are not assembled properly.	First insert the top of the milk container under the hook at the top of the frame. Then press the bottom part of the container. You hear a click when it locks into place.
The machine seems to be leaking.	The machine uses water to rinse the internal circuit and brew group. This water flows through the internal system directly into the drip tray. This is normal.	Empty the drip tray every day or as soon as the 'drip tray full' indicator pops up through the drip tray cover. Tip: Place a cup under the dispensing spout to collect rinsing water and reduce the amount of water in the drip tray.
	The drip tray is too full and has overflowed which makes it look like the machine is leaking.	Empty the drip tray every day or as soon as the 'drip tray full' indicator pops up through the drip tray cover.

Problem	Cause	Solution
	The water tank is not fully inserted and air is drawn into the machine.	Make sure the water tank is in the correct position: remove it and insert it again pushing it as far as possible.
	The brew group is dirty/clogged.	Rinse the brew group.
	The machine is not placed on a horizontal surface.	Place the machine on a horizontal surface so that the drip tray does not overflow and the 'drip tray full' indicator works properly.
	The water tank is not fully inserted and air is drawn into the machine.	Make sure the water tank is in the correct position: remove it and insert it again pushing it as far as possible.
I cannot activate the AquaClean water filter and the machine asks for descaling.	The filter has not been installed or replaced in time after the AquaClean water filter light started to flash. This means your machine is not completely limescale free.	Descale your machine first and then install the AquaClean water filter.
The new water filter does not fit.	You are trying to install another filter than the AquaClean water filter.	Only the AquaClean water filter fits into the machine.
	The rubber ring on the AquaClean water filter is not in place.	Place back the rubber ring on the AquaClean water filter.
The machine is making a loud noise.	It is normal that your machine makes noise during use.	If the machine starts to make a different kind of noise, clean the brew group and lubricate it (see 'Lubricating the brew group').
	The AquaClean water filter was not prepared properly and air is now drawn into the machine.	Remove the AquaClean water filter from the water tank and properly prepare it for use before you place it back. See chapter 'AquaClean water filter' for step-by-step instructions.
	The water tank is not fully inserted and air is drawn into the machine.	Make sure the water tank is in the correct position: remove it and insert it again pushing it as far as possible.

Technical specifications

The manufacturer reserves the right to improve the technical specifications of the product. All the preset quantities are approximate.

Description	Value
Size (w x h x d)	246 x 372 x 433 mm
Weight	7 - 7.5 kg

Power cord length	800-1200 mm
Water tank	1.8 litres, removable
Coffee bean hopper capacity	275 g
Coffee grounds container capacity	12 pucks
LatteGo (milk container) capacity	250 ml
Adjustable spout height	85-145 mm
Nominal voltage - Power rating - Power supply	See the rating label on the back of the machine (Fig. A10)

目录

咖啡机概述 (图 A)	24
控制面板 (图 B)	25
简介	25
首次使用之前	26
冲煮饮品	27
调节咖啡机设置	30
取下并插入冲煮组件 (萃取机芯)	32
清洁和保养	33
AquaClean 滤水芯	35
设置水硬度	37
除垢程序 (30 分钟)	38
订购配件	39
故障处理方法	39
技术规格	45

咖啡机概述 (图 A)

A1 控制面板	A- 带型号的数据标签 10
A2 杯架	A- 水箱 11
A3 咖啡粉槽	A- 热水出水口 12
A4 咖啡豆仓盖	A- 咖啡渣盒 13
A5 可调节咖啡出水口	A- 咖啡渣盒挡板 14
A6 研磨设置旋钮	A- 水盘盖 15
A7 咖啡豆仓	A- 水盘 16

A8 冲煮组件

A- “接水盘已满”指示标
17

A9 维护舱门

附件A- 蒸汽奶棒（仅限于特定型号）
18A- LatteGo（奶缸）（仅限于特定
19 型号）**控制面板（图 B）**

请参阅图 B，简要了解所有按钮和图标。下面提供了相关说明。

i 一些按钮/图标仅适用于特定型号。

B1 开/关按钮

B7 警告图标

B2 饮料图标*

B8 启动指示灯

B3 香味浓度/预研磨咖啡图标

B9 启动/停止  按钮

B4 饮料量图标

B10 除垢图标

B5 奶量图标（仅适用于特定型号）

B11 AquaClean 图标

B6 咖啡温度图标（仅适用于特定型号）

* 饮料图标：浓缩咖啡、加长浓缩咖啡、咖啡、美式咖啡、卡布奇诺、拿铁玛琪朵、热水、拿铁咖啡、蒸汽（仅适用于特定型号）

简介

欢迎购买并使用飞利浦全自动咖啡机！为了您能充分享受我们提供的支持，请关注我们的官方微信公众号、下载飞利浦智慧家 APP，获取更多的产品信息与服务！



飞利浦家电官方



飞利浦智慧家

在第一次使用本咖啡机前，请仔细阅读单行本安全手册，并妥善保管以供日后参考。

首次使用前，请务必冲洗所有会与水和牛奶接触的可拆卸配件。为了帮助您学会使用并充分利用好您的咖啡机，我们通过多种途径为您提供支持。在包装盒中，您可以找到以下资料：

- 1 快速入门指南，其中包含图示使用说明以及有关清洁和保养的信息。
- 2 安全手册，其中包含咖啡机安全使用说明。
- 3 有关在线支持（此用户手册详细版、常见问题、视频等），请扫描本手册封面上的二维码下载飞利浦智慧家 APP。

i 此意式浓缩咖啡机有多个不同版本，分别具有不同的功能特性。每个版本各对应自己的型号。您可以在产品背后的铭牌上找到您产品的型号（请参阅图 A10）。

i 我们的所有产品均已通过咖啡测试。尽管已对其进行充分清洁，但产品中仍可能会有一些咖啡痕迹残留。我们保证本产品是全新的。

咖啡机自动调节达到更佳咖啡口感所需使用的咖啡粉量。起初使用时，您应冲煮 5 杯咖啡，让咖啡机完成自动调节。

在第一次使用前，请务必冲洗 LatteGo（奶缸）或蒸汽奶棒。

首次使用之前

1. 设置咖啡机

打开咖啡机后，热水出水口或咖啡出水口可能会喷出一些水。这是正常现象。

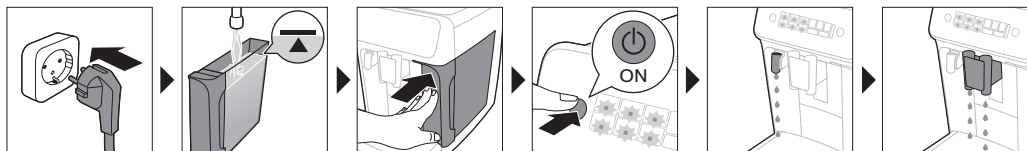

2. 激活 AquaClean 滤水芯（5 分钟）

i 并非所有型号都附赠 AquaClean 滤水芯：您可以从我们授权网店、飞利浦家电官方服务热线、飞利浦家电特约服务中心购买。*可用性因国家/地区而异。

有关详细信息，请参阅“AquaClean 滤水芯”一章。

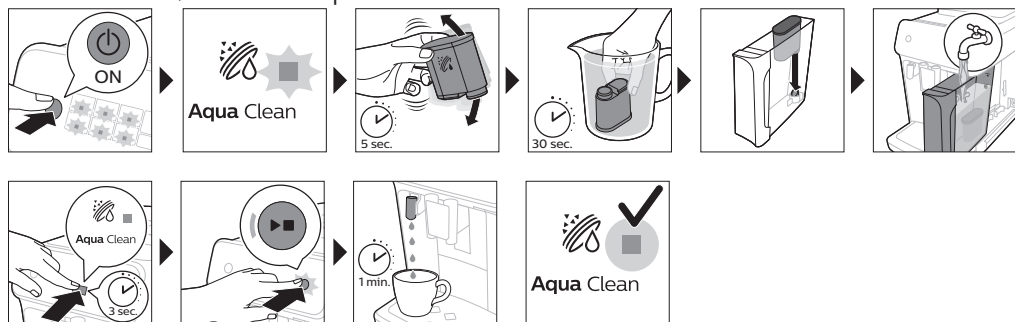

3. 设置水硬度

请参阅“设置水硬度”一章的逐步说明。默认水硬度设置为 4：硬水。

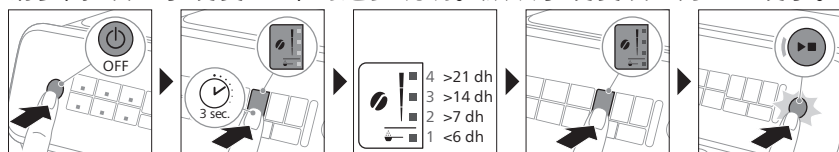

4. 安装 LatteGo (仅适用于特定型号)

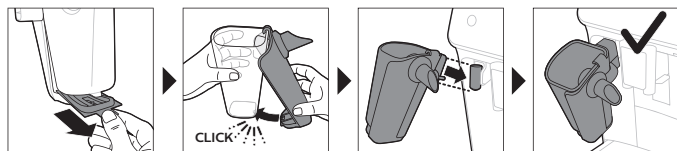

5. 安装经典奶泡器 (仅限于特定型号)

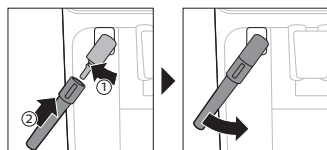

冲煮饮品

一般步骤

- 1 向水箱中注入纯净水，并在咖啡豆槽中加入咖啡豆。
- 2 按下开/关按钮打开咖啡机。

- 咖啡机开始加热，并执行自动冲洗周期。在加热过程中，饮品图标的指示灯依次缓慢点亮并熄灭。
 - 当饮品图标的所有指示灯长亮时，表示咖啡机已准备就绪，可以开始使用。
- 3 将杯子放在咖啡流出口下方。上下滑动咖啡流出口，根据您使用的杯子或玻璃杯的大小调节流出口的高度 (图 1)。

对饮料进行个性化定制

使用本咖啡机，您可以根据自身喜好调节饮料设置。选择一种饮料后，您可以：

- 1 轻击香味浓度图标，调节香味浓度 (图 2)。共有 3 种浓度，最低浓度表示香味浓度最温和，最高浓度表示香味浓度最强烈。
- 2 轻击饮料量 (图 3)和/或奶量图标（仅适用于特定型号）调节饮料量。共有 3 种量级：低、中和高。

i您还可以根据您的个人喜好调节咖啡温度 (请参见“调节咖啡温度”)。

使用咖啡豆冲煮咖啡

- 1 要冲煮咖啡，请轻击您想要的饮料图标。
 - 香味浓度和量级指示灯会点亮，并显示上次选择的设置。
 - 您现在可以根据您喜爱的饮料口感进行调节 (请参见“对饮料进行个性化定制”)。
- 2 按下启动/停止▶按钮。
 - 流出饮料时，饮料图标的指示灯闪烁。

i仅限于特定型号：美式咖啡由浓缩咖啡和水调制而成。当您选择美式咖啡后，咖啡机会先流出浓缩咖啡，然后流出水。

- 3 如果要在咖啡机结束前停止流出咖啡，请再次按下启动/停止▶按钮。

i要一次冲煮 2 杯咖啡，请轻击饮料图标两次。2x 指示灯点亮。

使用 LatteGo (奶缸) 冲煮奶咖饮品

ALatteGo 包含奶缸、容器架和容器盖。要避免溢漏，请确保容器架和奶缸都已正确组装，再装入奶缸。

- 1 要安装 LatteGo，请先将奶缸的顶部插入容器架顶部的挂钩下 (图 4)。然后按压奶缸的底部，使其处于正确位置。听到喀哒一声即表示已锁定到位 (图 5)。

注意：确保奶缸和容器架干净，然后再连接它们。

- 2 略微倾斜 LatteGo，将其放在热水流出口上 (图 6)。然后按正确方向按压，直到将其锁定到位 (图 7)。

- 3 在 LatteGo 中注入牛奶，直至达到您要冲煮的饮品在奶缸上对应的指示标记 (图 8)。不能超过奶缸上的最大指示标记。

i 如果您要调节为其他奶量，在奶缸上注入的奶量可以高于或低于此饮品在 LatteGo 上对应的指示标记。

💡 使用直接从冰箱里取出的牛奶可获得更佳口感。

- 4 将 1 个杯子放在接水盘上。
- 5 轻击您想要的奶咖饮品图标。
 - 现在可以根据您的喜好调节饮品 (请参见“对饮料进行个性化定制”)。
- 6 按下启动/停止 **▶■** 按钮。
 - 流出饮品时，饮品图标的指示灯闪烁。当您冲煮卡布奇诺或拿铁玛奇雅朵时，咖啡机先流出牛奶，然后流出咖啡。
 - 要在咖啡机流出预设量之前停止流出牛奶，请按下启动/停止 **▶■** 按钮。
- 7 要在咖啡机结束前停止流出全部饮品 (牛奶和咖啡)，请按住启动/停止 **▶■** 按钮。

用经典奶泡器制作奶泡

💡 使用直接从冰箱里取出的牛奶可以让奶泡质量达到最佳。

- 1 将咖啡机上的黑色硅胶手柄向左倾斜，将奶泡器滑接到上面 (图 9)。
- 2 在牛奶壶中注入约 100 毫升牛奶 (制作卡布奇诺) 或约 150 毫升牛奶 (制作拿铁玛琪朵)。
- 3 将奶泡器插入牛奶中大约 1 厘米。
- 4 轻击蒸汽图标 (图 10)。
 - 蒸汽图标上的指示灯会点亮，启动指示灯开始闪烁。
- 5 按下启动/停止 **▶■** 按钮制作奶泡 (图 11)。
 - 咖啡机开始加热，让蒸汽进入牛奶，使牛奶起泡。
- 6 当牛奶壶中的奶泡达到需要的量后，再次按下启动/停止 **▶■** 按钮停止制作奶泡。

i 打奶泡时间切勿超过 90 秒。90 秒后将自动停止打奶泡。

i 在奶泡制作期间，您不必为了获得最佳奶泡质量而移动牛奶壶。

使用预磨咖啡粉冲煮咖啡

您可以选择使用预磨咖啡粉而非咖啡豆，例如用其制作不同的咖啡或低因咖啡。

- 1 按开/关按钮打开咖啡机，然后等待咖啡机准备就绪。
- 2 打开预磨咖啡粉槽盖，将 3 茶匙咖啡粉 (约 8 克) 倒入其中 (图 12)。然后合上盖。

30 简体中文

- 3 将杯子放在咖啡出水口下方。
- 4 选择一种饮料。
- 5 按住香味浓度图标 3 秒钟 (图 13)。- 预研磨咖啡指示灯亮起，启动指示灯开始闪烁。
- 6 按下启动/停止 ▶■ 按钮。
- 7 如果要在咖啡机结束工作前停止流出咖啡，请再次按下启动/停止 ▶■ 按钮。

i 如果使用预研磨咖啡，一次只能冲煮一杯咖啡。

i 预研磨咖啡不能保存为上次选定的浓度设置。每次使用预研磨咖啡时，都需要按住香味浓度图标 3 秒钟。

i 当您选择预研磨咖啡时，无法选择不同的香味浓度。

放出热水

- 1 取下 LatteGo 或蒸汽奶棒（如果已安装）。
- 2 点按热水图标 (图 14)。- 饮品量指示灯点亮，显示上次选择的针对热水的饮品设置。
- 3 点按饮品量图标，根据您的喜好调节热水量 (图 3)。
- 4 按下启动/停止 ▶■ 按钮。- 热水图标指示灯闪烁，并从热水出水口流出热水 (图 15)。
- 5 如果要在咖啡机结束前停止流出热水，请再次按下启动/停止 ▶■ 按钮。

调节咖啡机设置

调整待机时间

- 1 按下电源按钮关闭咖啡机。
- 2 当咖啡机关断电源后：按住 Calc / Clean 图标 (图 16)，直到 Calc / Clean 灯和香味浓度灯亮起 (图 17)。
- 3 点击香味浓度图标，选择所需的待机时间：15 分钟、30 分钟、60 分钟或 180 分钟。香味浓度图标的 1、2、3 或 4 个灯分别亮起。
- 4 待机时间设定完成后，按下启动/停止按钮。咖啡机关闭。
- 5 再次按下开/关按钮打开咖啡机。

调节饮料的最高默认设置

咖啡机为每种饮料提供 3 种默认设置：低、中、高。您只能调节最高量的设置。当启动指示灯开始闪烁时，即可存储新设定的饮料量。

i 开始设定牛奶饮料的量之前，请安装 LatteGo 并注入牛奶。

- 1 要调节最高量设置，按住您想要调节的饮料图标 3 秒钟。
 - 上方饮料量图标指示灯和上方奶量图标指示灯（仅适用于特定型号）开始闪烁，且启动/停止按钮开始闪烁，即表示您处于设定模式。
- 2 按下启动/停止按钮。咖啡机开始冲煮所选饮料。
 - 首先，启动指示灯持续点亮。当咖啡机准备好存储调节后的量时，启动/停止指示灯开始闪烁。
- 3 当杯中的咖啡或牛奶达到所需的量后，再次按下启动/停止按钮。
 - 如果制作卡布奇诺或拿铁玛琪朵，将先流出牛奶。如果制作拿铁咖啡，将先流出咖啡。当杯中的牛奶（如果制作拿铁咖啡，则为咖啡）达到所需的量后，按下启动/停止按钮。咖啡机自动流出咖啡（如果制作拿铁咖啡，则为牛奶）。当杯中达到所需的量后，再次按下启动/停止按钮。

为饮料设定新的最高默认量后，每次选择该饮料的最高量时，咖啡机将按照此最新量流出饮料。

i 您只能调节最高默认量。

i 如果您要还原默认量设置，请参阅“恢复出厂设置”。

调节咖啡温度

咖啡机上没有温度图标

- 1 按下电源按钮**关闭**咖啡机。
- 2 当咖啡机关断电源后：按住咖啡量图标，直至此图标的指示灯点亮(图 18)。
- 3 轻击饮料量图标，选择所需的温度：正常、高或最大。
 - 分别有 1 个、2 个或 3 个指示灯亮起。
- 4 咖啡温度设定完成后，按下启动/停止按钮。
- 5 再次按下电源按钮打开咖啡机。

i 如果您没有关闭咖啡机，咖啡机将在一段时间后自动关闭。

咖啡机上有温度图标（仅适用于 EP3221）

- 1 多次轻击咖啡温度图标，选择所需的温度。

恢复出厂设置

咖啡机可以随时恢复饮料默认设置。

i 只能在咖啡机关闭时恢复默认设置。

- 1 按下开/关按钮关闭咖啡机。
- 2 按住浓缩咖啡图标 3 秒钟。
 - 饮料设置图标中间的指示灯点亮。启动/停止指示灯开始闪烁，表示现在可以恢复设置。
- 3 按下启动/停止▶按钮，以确认您希望恢复设置。
- 4 再次按下开/关按钮打开咖啡机。

调整研磨机设置

您可以使用咖啡豆容器中的研磨粗细调节旋钮更改咖啡浓度。研磨设置越低，咖啡豆研磨越细，咖啡越浓。有 12 档不同的研磨粗细度可供选择。

咖啡机已经过设置，可将您的咖啡豆煮出最好的味道。因此，在您冲煮 100-150 杯咖啡（大约使用 1 个月）之前，我们建议您不要进行研磨粗细调节。

i 调整后的设置，将会在新冲煮的 2-3 杯饮品后体现。

A 为防止损坏研磨器，请勿将研磨粗细调节旋钮一次转动多档。

- 1 将杯子放在咖啡出水口下方。
- 2 打开咖啡豆仓盖。
- 3 轻击浓缩咖啡图标，然后按下启动/停止▶按钮。
- 4 当研磨机开始研磨时，按下研磨设置旋钮，并将其向左或向右旋转。（图 19）

取下并插入冲煮组件（萃取机芯）

有关如何拆卸、插入和清洁冲煮组件（萃取机芯）的详细视频说明，请转至飞利浦智慧家 APP。

从咖啡机上取下冲煮组件

- 1 关闭咖啡机。
- 2 取出水箱，并打开维护舱门（图 20）。
- 3 按下拉出手柄（图 21），然后拉动冲煮组件的把手，将其从咖啡机上取下（图 22）。

重新插入冲煮组件

A 在将冲煮组件滑回咖啡机前，请确保它处于正确位置。

- 1 检查冲煮组件的位置是否正确。冲煮组件一侧的黄色柱体上的箭头必须对准黑色箭头和 N（图 23）。

- 如果它们未对准，请向下推操纵杆，直至它触及冲煮组件 (图 24)的底座。
- 2 将冲煮组件沿着侧面 (图 25)的导槽推回咖啡机内，直至其卡入到位并发出“咔哒”声 (图 26)。请勿按 拉出 按钮。
 - 3 关闭维护舱门，并将水箱放回。

清洁和保养

定期清洁和保养可使您的咖啡机保持理想状态，并确保长时间保持稳定的咖啡流和供应美味的咖啡。

请参阅下表详细了解清洁咖啡机所有可拆卸部件的时间和方式。您可以通过飞利浦智慧家 APP 查找更多详细信息和视频说明。请参见图 D，简要了解可以用洗碗机清洗的部件。

可拆卸部件	清洁时间	清洁方式
萃取机芯	每周一次	从咖啡机上取下萃取机芯 (请参见“取下并插入冲煮组件 (萃取机芯)”)。放在水龙头下冲洗 (请参见“在水龙头下清洁冲煮组件 (萃取机芯)”)。
	每月一次	使用咖啡除油片清洁萃取机芯 (请参见“使用咖啡去油片清洁冲煮组件 (萃取机芯)”)。
蒸汽奶棒	每次使用后	先将蒸汽奶棒安装到咖啡机上并流出热水，以进行彻底清洁。然后将蒸汽奶棒从咖啡机上取下来，并将其拆开。在水龙头下或在洗碗机中清洗所有部件。
咖啡粉槽	每周检查一次咖啡粉槽，看它是否堵塞。	拔掉咖啡机插头并取下萃取机芯。打开咖啡粉槽盖，将勺柄插入其中。上下移动勺柄，直到堵塞的咖啡粉落下 (图 27)。扫描二维码以下载飞利浦智慧家 APP，观看详细的视频说明。
咖啡渣盒	在咖啡机提示时倒空咖啡渣盒。每周清洁一次。	在咖啡机开机状态下，取下咖啡渣盒。加少许洗涤液放在水龙头下冲洗，或者放在洗碗机中清洗。咖啡渣盒挡板不可放入洗碗机中清洗。

可拆卸部件	清洁时间	清洁方式
接水盘	每天倒空接水盘，或者从水盘中弹出红色的“接水盘已满”指示标时倒空接水盘(图 28)。每周清洁一次接水盘。	取走接水盘(图 29)，并加少许洗涤剂，放在水龙头下冲洗。您还可以在洗碗机中清洁接水盘。 咖啡渣盒挡板(图 A14)不可放入洗碗机中清洗。
LatteGo	每次使用后	将 LatteGo 放在水龙头下冲洗或在洗碗机中清洁。
萃取机芯的润滑	每 2 个月	使用润滑脂润滑萃取机芯(请参见“滑润萃取机芯”)。
水箱	每周一次	在水龙头下冲洗水箱。

清洁冲煮组件（萃取机芯）

定期清洁冲煮组件（萃取机芯）可防止咖啡残渣堵塞内部回路。通过飞利浦智慧家 APP 查找有关如何拆卸、插入和清洁冲煮组件（萃取机芯）的支持视频。

在水龙头下清洁冲煮组件（萃取机芯）

- 1 取下冲煮组件(请参见“取下并插入冲煮组件（萃取机芯）”)。
- 2 在水龙头下彻底冲洗冲煮组件。仔细清洁冲煮组件上部的过滤网(图 30)。
- 3 让冲煮组件晾干，然后将它放回。请勿用布擦干冲煮组件，以免纤维堆积在冲煮组件内。

使用咖啡去油片清洁冲煮组件（萃取机芯）

- 1 将杯子放在咖啡出水口下方。将纯净水注入水箱。
- 2 将咖啡油去除片放入咖啡粉槽。
- 3 轻击咖啡图标，然后按住香味浓度图标 3 秒钟，以选择预研磨咖啡功能(图 2)。
- 4 不要添加咖啡粉。按下启动/停止▶按钮启动冲煮周期。冲煮半杯水后，拔下咖啡机插头。
- 5 让咖啡除油片的溶液浸泡至少 15 分钟。
- 6 重新插上电源插头并打开咖啡机，完成冲煮周期。倒空杯子。
- 7 取出水箱，并打开维护舱门。取下冲煮组件(请参见“从咖啡机上取下冲煮组件”)，在水龙头下彻底冲洗。
- 8 重新插入冲煮组件、水箱，并将杯子放在咖啡出水口下方。
- 9 轻击咖啡图标，然后按住香味浓度图标 3 秒钟，以选择预研磨咖啡功能(图 2)。不要添加咖啡粉。按下启动/停止▶按钮启动冲煮周期。重复此操作两次。倒空杯子。

滑润萃取机芯

每 2 个月滑润一次冲煮组件可确保活动部件持续平滑运行。

- 1 在萃取机芯活塞（灰色部件）上涂抹薄薄一层滑润脂（图 31）。
- 2 在萃取机芯底部的轴（黄色部件）周围涂抹薄薄一层滑润脂（图 32）。
- 3 在两侧的导轨上均涂抹薄薄一层滑润脂（图 33）。

清洁 LatteGo（奶缸）

每次使用 LatteGo 后进行清洁

- 1 从咖啡机（图 34）上取下 LatteGo。
- 2 倒出剩余的牛奶。
- 3 按下释放按钮，并将奶缸从 LatteGo 容器架上取下（图 35）。
- 4 将所有部件放在洗碗机中进行清洁，或者加一些洗涤液，放在流出温水的水龙头下清洗。

清洁蒸汽奶棒。

每次使用蒸汽奶棒后进行清洁

每次使用蒸汽奶棒后进行清洁，以保持卫生，避免残留牛奶聚积。

- 1 在蒸汽奶棒下方放一个杯子。
- 2 轻击蒸汽图标，然后按下启动/停止▶按钮开始放出蒸汽，以清除任何可能留在蒸汽奶棒内的牛奶。
- 3 要在几秒钟之后停止放出蒸汽，请再次按下启动/停止▶按钮。
- 4 用湿布清洁蒸汽奶棒。

每日清洁经典奶泡器

- 1 让奶泡器完全冷却。
- 2 将奶泡器向左倾斜（图 36），取下金属部件和硅胶部件（图 37）。
- 3 拆下两个部件，用清水或在洗碗机中清洗（图 38）。确保金属管上的小孔已完全清洁，无残留牛奶堵塞（图 39）。
- 4 将两个奶泡器部件重新组装在一起，再将奶泡器重新装到咖啡机上。

AquaClean 滤水芯

该款咖啡机支持使用 AquaClean 滤水芯。您可以将 AquaClean 滤水芯放在水箱中，以保存咖啡风味。它也会减少积聚在咖啡机上的水垢，减少除垢需要。您可以从我们授权网店、飞利浦家电官方服务热线、飞利浦家电特约服务中心购买 AquaClean 滤水芯。有任何问题，可以拨打飞利浦家电官方服务热线：4008-203-160。

i *可用性因国家/地区而异。

AquaClean 图标和指示灯

咖啡机带 AquaClean 滤水芯指示灯 (图 40)，用于指示滤水芯状态。在下表中查看当指示灯点亮或闪烁时需要采取的操作。



当您首次使用咖啡机时，AquaClean 指示灯开始闪烁橙色。这表示您可以开始使用 AquaClean 滤水芯。如果您不激活 AquaClean 滤水芯，指示灯将在一段时间后自动熄灭。



您安装滤水芯并通过 AquaClean 图标激活后，AquaClean 指示灯变为蓝色，表示 AquaClean 滤水芯已启用。



滤水芯用旧后，AquaClean 指示灯再次闪烁橙色，提醒您更换新的滤水芯。



AquaClean 橙色指示灯熄灭后，您仍可激活 AquaClean 滤水芯，但需要先为咖啡机除垢。

激活 AquaClean 滤水芯（5 分钟）

i 咖啡机不会自动检测水箱中是否安装了滤水芯。因此您需要通过 AquaClean 图标激活每个新的 AquaClean 滤水芯。

AquaClean 橙色指示灯熄灭后，您仍可激活 AquaClean 滤水芯，但需要先为咖啡机除垢。

i 开始使用 AquaClean 滤水芯前必须确保咖啡机中完全没有水垢。

激活 AquaClean 滤水芯前，必须按照以下说明浸泡在水中，以做好准备。如果您不这样做，可能会使空气而不是水被吸入咖啡机，导致发出很大噪音并且无法冲煮咖啡。

- 1 确保咖啡机已打开。
- 2 摇晃滤水芯约 5 秒 (图 41)。
- 3 将滤水芯倒置浸入冷水壶中，然后摇晃/按压滤水芯 (图 42)。
- 4 滤水芯现在已使用就绪，可插入水箱。
- 5 将滤水芯垂直插入水箱中的滤水芯接口。将它尽可能用力往下按 (图 43)。
- 6 往水箱中注入清水，然后将其重新放入咖啡机内。
- 7 取下 LatteGo (如果已安装)。
- 8 在热水流出口/奶泡器下方放一只碗。
- 9 按住 AquaClean 图标 3 秒钟 (图 44)。启动指示灯将开始闪烁。

- 10 按下启动/停止 ▶■按钮开始激活过程。
- 11 热水出水口/奶泡器中将流出热水（3 分钟）。
- 12 激活过程完成后，蓝色 AquaClean 指示灯亮起，表示已正确激活 AquaClean 滤水芯。

更换 AquaClean 滤水芯（5 分钟）。

滤水芯过滤 95 升水后将停止工作。AquaClean 指示灯变为橙色并开始闪烁，提醒您更换滤水芯。只要指示灯在闪烁，您可以直接更换滤水芯，无需先为咖啡机除垢。如果您不更换 AquaClean 滤水芯，橙色指示灯最终会熄灭。在这种情况下，您仍可以更换滤水芯，但首先需要为咖啡机除垢。

当 AquaClean 橙色指示灯闪烁时：

- 1 取出旧的 AquaClean 滤水芯。
- 2 按照“激活 AquaClean 滤水芯（5 分钟）”一章安装并激活新滤水芯。

i 即使咖啡机尚未指示需要更换，也请至少每 3 个月更换一次 AquaClean 滤水芯。

设置水硬度

设置水硬度

i 我们建议您将水质硬度调节至您当地的水质硬度，以便让咖啡机保持更佳性能并延长使用寿命，同时省去频繁为咖啡机除垢的麻烦。默认水硬度设置为 4：硬水。

为咖啡机设置正确的水硬度：

- 1 按下开/关按钮**关闭**咖啡机。
- 2 关闭咖啡机后，轻击并按住香味浓度图标，直到图标的所有灯熄灭（图 2）。
- 3 轻击香味浓度图标 1、2、3 或 4 次。亮起的指示灯数量应该与水硬度表中的相应数字相同。
- 4 设置正确的水质硬度后，按下启动/停止▶■按钮。

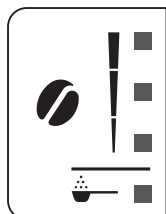

4	4 个红点	>21 dh
3	3 个红点	>14 dh
2	2 个红点	>7 dh
1	1 个红点或 4 个绿点	<6 dh

i 您只需设置一次水质硬度，因此香味浓度功能用于选择水质硬度。这不会影响您以后为饮料选择香味浓度。

除垢程序（30 分钟）

要清洁咖啡机并为其除垢，我们建议使用飞利浦除垢剂（如果在您所在的国家/地区中有售）。在任何情况下都不应使用基于硫酸、盐酸、氨基磺酸或乙酸（醋）的除垢剂，因为这可能损坏咖啡机内的水回路，而且不能完全溶解水垢。如果没有为本产品除垢，您的保修也将失效。您可以从我们授权网店、飞利浦家电官方服务热线、飞利浦家电特约服务中心购买飞利浦除垢剂。有任何问题，可以拨打飞利浦家电官方服务热线：4008-203-160。

当除垢/清洁指示灯亮起时，您需要为咖啡机除垢。

- 1 确保咖啡机已打开。
- 2 取下 LatteGo 或蒸汽奶棒（如果已安装）。
- 3 取出接水盘和咖啡渣盒，将其倒空并放回原位。
- 4 取出并倒空水箱。然后取下 AquaClean 滤水芯。
- 5 将整瓶飞利浦除垢剂倒入水箱中，然后向水箱中加水，直至达到除垢/清洁标记（图 45）。然后将其放回咖啡机。
- 6 将一个大容器（1.5 升）放在咖啡流出口和水流出口下方。
- 7 按住除垢/清洁图标 3 秒钟，然后按下启动/停止 **▶** 按钮。
- 8 除垢程序的第一个阶段启动。除垢程序持续约 30 分钟，包括一个除垢周期和一个冲洗周期。在除垢周期中，除垢/清洁指示灯闪烁，表示正在除垢。
- 9 让咖啡机放出除垢溶液，直至显示屏提示您水箱已空。
- 10 倒空并冲洗水箱，然后向水箱中加入清水，直至达到除垢/清洁标记。
- 11 倒空容器，然后放回咖啡出水口和水出水口的下方。再次按下启动/停止 **▶** 按钮。
- 12 冲洗阶段（除垢周期的第二阶段）将开始并持续 3 分钟。在此阶段，控制面板上的指示灯亮起并熄灭，表示正在冲洗。
- 13 一直等到咖啡机停止出水。当咖啡机停止出水时，除垢程序完成。
- 14 咖啡机将再次加热。当饮品图标的指示灯变亮时，表明咖啡机已准备就绪，可以再次使用。
- 15 安装并激活浸入水箱中的新 AquaClean 滤水芯（请参见“激活 AquaClean 滤水芯（5 分钟）”）。
 - 除垢程序结束后，AquaClean 指示灯闪烁片刻，提醒您安装新的 AquaClean 滤水芯。

💡 提示：使用 AquaClean 滤水芯可减少除垢需求！

除垢程序中断时采取的操作

您可以通过按控制面板上的电源按钮退出除垢程序。如果除垢程序在彻底完成前被中断，请执行以下操作：

- 1 倒空净水箱，并用水彻底冲洗。
- 2 向水箱中加入清水，直至达到除垢标记，然后再次打开咖啡机。咖啡机会加热，并执行自动冲洗周期。
- 3 在冲煮任何饮料前，执行手动冲洗周期。要执行手动冲洗周期，先多次轻击热水图标(图 14)，将水箱的热水放出一半，然后在不加研磨咖啡的情况下冲煮 2 杯预研磨咖啡。

i 如果除垢程序未完成，需尽快对咖啡机再执行一次除垢程序。

订购配件

要清洁咖啡机并为其除垢，我们建议您使用专用的清洁产品，如飞利浦除垢液、飞利浦 AquaClean 滤水芯和咖啡机专用去油片。这些产品可以从我们授权网店、飞利浦家电官方服务热线、飞利浦家电特约服务中心购买。有任何问题，可以拨打飞利浦家电官方服务热线：4008-203-160。您可以在产品背后的铭牌上找到您产品的型号。

i Brita 滤水芯与此咖啡机不兼容。

故障处理方法

本章汇总了使用咖啡机时最常遇到的问题。如需支持，请通过您的应用程序商店或扫描本手册封面上的二维码下载飞利浦智慧家 APP。

www.philips.com/support 上提供了支持视频和完整的常见问题列表。如果您无法解决问题，请联系您所在国家/地区的客户服务中心。

警告图标

警告图标

解决方法



“水箱无水”指示灯亮起

- 水箱即将变空。向水箱中注入纯净水，直至达到最高水位标示处。
- 水箱没有放好。将水箱放回。



“清空咖啡渣盒”指示灯亮起

- 表示咖啡渣盒已满。在咖啡机打开时取下并倒空咖啡渣盒。至少等待 5 秒钟，然后重新插入咖啡渣盒。

警告图标 解决方法



警报指示灯亮起

- 咖啡渣盒和/或接水盘未装好或未正确放置。放回咖啡渣盒和/或接水盘，确保它们处于正确位置。
- 维护舱门打开。取下水箱，并确保维护舱门已关闭。



警报指示灯闪烁

- 萃取机芯未装好或未正确放置。取出萃取机芯，并确保其已锁定到位。请参阅“取下和插入萃取机芯”一章的逐步说明。
- 萃取机芯堵塞。取下萃取机芯，放在水龙头下冲洗。自然晾干后，润滑萃取机芯，然后将其放回咖啡机。请参阅“清洁和保养”一章的逐步说明。



警报指示灯亮起，并且启动指示灯闪烁。

咖啡机中残留有空气。要排出咖啡机中的空气，请向水箱中注入水，在蒸汽奶棒下方放一个杯子，按下闪烁的启动/停止按钮。

请注意：从蒸汽奶棒中会流出少量热水，以排出空气。



Aqua Clean

AquaClean 指示灯闪烁：放置或更换 AquaClean 滤水芯并将其激活。请参阅“AquaClean 滤水芯”一章的逐步说明。



Calc / clean

除垢指示灯缓慢闪烁：为咖啡机除垢。

警告图标

解决方法



饮品图标的指示灯依次亮起然后熄灭。

咖啡机正在加热和/或尝试排出吸入的空气。请等待，直到所有饮品指示灯长亮。



所有警告图标的指示灯闪烁。



将咖啡机的插头拔下后再次插上，以重置咖啡机。在重新打开咖啡机电源前，先执行以下步骤：



- 从水箱中取出 AquaClean 滤水芯。



- 将水箱放回。将其尽量用力推入咖啡机，以确保其处于正确位置。



- 打开预磨咖啡粉槽盖，并检查是否被咖啡粉堵塞。要进行清洁，请将勺柄插入预磨咖啡粉槽中并上下移动，直到堵塞的咖啡粉掉落(图 27)。取下萃取机芯，并清除所有掉落的咖啡粉。放回干净的萃取机芯。



- 重新打开咖啡机电源。

如果问题已解决，但 AquaClean 滤水芯没有充分准备好。先准备好 AquaClean 滤水芯，再按照“激活 AquaClean 滤水芯（5 分钟）”一章的步骤 1 和 2 放回滤水芯。

如果指示灯仍然闪烁，可能是因为咖啡机过热。关闭咖啡机，并在 30 分钟后重新打开。如果指示灯仍然闪烁，请联系您所在国家/地区的客户服务中心。有关联系详细信息，请参阅国际保修卡。

故障排除表

本章汇总了使用咖啡机时最常遇到的问题。www.philips.com/support 上提供了支持视频和完整的常见问题列表。如果您无法解决问题，请联系您所在国家/地区的客户服务中心。有关联系详细信息，请参阅保修卡。

问题	原因	解决方法
接水盘会迅速注满。	这是正常现象。咖啡机用水冲洗内部回路和萃取机芯。一部分水通过内部系统直接流入接水盘。	每天倒空接水盘，或者从接水盘盖中弹出红色的“接水盘已满”指示标时倒空接水盘。提示：将一个杯子放在流出口下方接盛流出的冲洗水。
“清空咖啡渣盒”指示灯仍然亮起。	您在咖啡机关闭时清空了咖啡渣盒。	请始终在咖啡机打开时倒空咖啡渣盒。取下咖啡渣盒，并等待至少 5 秒钟，然后将其重新插入。

问题	原因	解决方法
咖啡渣盒未滿，但咖啡机仍然提示您清空渣槽。	在您上次倒空咖啡渣盒时，咖啡机未重置计数器。	取下咖啡渣盒，并等待至少 5 秒钟，然后将其重新插入。这样才能让咖啡粉计数器重置为 0。
		请始终在咖啡机打开时倒空咖啡渣盒。如果在咖啡机关闭时清空咖啡渣盒，咖啡粉计数器不会重置。
咖啡渣盒太满，但“清空咖啡渣盒”指示灯未亮起。	您取出了接水盘，但没有清空咖啡渣盒。	当您取出接水盘后，即使只有少数勺数的咖啡，也要清空咖啡渣盒。这样才能让咖啡粉计数器归零。
无法取出萃取机芯。	萃取机芯的位置不正确。	按以下方式重置咖啡机：关闭维护舱门，并将水箱放回。关闭咖啡机，然后再重新打开。再次尝试取出萃取机芯。请参阅“取下并插入萃取机芯”一章的逐步说明。
无法插入萃取机芯。	萃取机芯的位置不正确。	按以下方式重置咖啡机：关闭维护舱门，并将水箱放回。请勿安装萃取机芯。关闭咖啡机并拔下插头。等待 30 秒，然后再插上咖啡机插头并打开咖啡机。之后，将萃取机芯放入正确位置，并将其重新插入咖啡机中。请参阅“取下并插入萃取机芯”一章的逐步说明。
咖啡太淡。	萃取机芯变脏或需要润滑。	取下萃取机芯，在水龙头下冲洗干净后晾干（请参见“从咖啡机上取下冲煮组件”）。然后润滑活动部件（请参见“润滑萃取机芯”）。
	咖啡机在执行自动调整程序。当您首次使用咖啡机、更换咖啡豆种类或长时间未使用后，此程序自动开始。	先冲煮 5 杯咖啡，以便让咖啡机完成自动调整程序。

问题	原因	解决方法
	研磨器的研磨度设置为太粗。	将研磨器的研磨度设定为较细（较低）设置。冲煮 2 到 3 杯饮品方可完全调整到不同的口感。
咖啡不够热。	设定的温度太低。	将温度设定为最高温度（请参见“调节咖啡温度”）。
	冰凉的杯子会降低饮品的温度。	通过用热水冲洗来预热杯子。
	添加牛奶会降低饮品的温度。	不管您是添加热牛奶还是冷牛奶，都会降低咖啡温度。通过用热水冲洗来预热杯子。
咖啡未流出或咖啡流速较慢。	AquaClean 滤水芯未做好妥善的安装准备。	取出 AquaClean 滤水芯，然后试着再冲煮一杯咖啡。如果这样做有效，请确保妥善准备好 AquaClean 滤水芯后，再将其放回。请参阅“AquaClean 滤水芯”一章的逐步说明。
		如果长时间未使用，您需要重新准备 AquaClean 滤水芯，然后将其放回。请参阅“激活 AquaClean 滤水芯”一章的步骤 1 至 3。
	AquaClean 滤水芯堵塞。	每 3 个月更换一次 AquaClean 滤水芯。滤水芯使用时间超过 3 个月后会堵塞。
	研磨器的研磨度设置为太细。	将研磨器的研磨度设定为较粗（较高）设置。请注意，这会影响咖啡的口感。
	萃取机芯脏了。	取下萃取机芯，然后在水龙头下冲洗（请参见“在水龙头下清洁冲煮组件（萃取机芯）”）。
	咖啡流出口脏了。	使用管道清洁剂或针清洁咖啡流出口及相应的孔。

问题	原因	解决方法
	咖啡粉槽堵塞	关闭咖啡机，取下萃取机芯。打开咖啡粉槽盖，将勺柄插入其中。上下移动勺柄，直到堵塞的咖啡粉落下 (图 27)。
	水垢堵塞了咖啡机回路。	为咖啡机除垢。当除垢指示灯开始闪烁时，务必为咖啡机除垢。
咖啡机可以研磨咖啡豆，但不出咖啡。	咖啡粉槽堵塞。	关闭咖啡机，取下萃取机芯。打开咖啡粉槽盖，将勺柄插入其中。上下移动勺柄，直到堵塞的咖啡粉落下 (图 27)。
牛奶不起泡。	配有 LatteGo 的咖啡机：LatteGo 未正确安装。	请确保奶缸已正确安装到 LatteGo 容器架上（听到咔嗒一声）。
	配有 LatteGo 的咖啡机：奶缸和/或 LatteGo 容器架变脏。	拆下 LatteGo 并在水龙头下冲洗这两个部件，或者放在洗碗机中清洗 (请参见“每次使用 LatteGo 后进行清洁”)。
	带蒸汽奶棒的咖啡机：蒸汽奶棒变脏。	彻底清洁蒸汽奶棒 (请参见“清洁蒸汽奶棒。”)。
	所用牛奶类型不适于制作牛奶泡沫。	奶泡效果因牛奶种类而异。建议使用咖啡专用牛奶可获得最佳效果。
牛奶从 LatteGo 奶缸的底部溢出。	未正确安装容器架和奶缸。	先将奶缸的顶部插入容器架顶部的挂钩下。然后按压奶缸的底部。听到喀哒一声即表示已锁定到位。
咖啡机似乎泄漏。	咖啡机用水冲洗内部回路和萃取机芯。水通过内部系统直接流入接水盘。这是正常现象。	每天倒空接水盘，或者从接水盘盖中弹出红色的“接水盘已满”指示标时倒空接水盘。提示：将一个杯子放在流出口下方接住冲洗水，以减少接水盘中的水量。
	接水盘太满并且已溢出，这看起来就像咖啡机发生了泄漏。	每天倒空接水盘，或者从接水盘盖中弹出红色的“接水盘已满”指示标时倒空接水盘。

问题	原因	解决方法
	水箱未正确安装到位，空气被吸入咖啡机。	请确保水箱处于正确位置：取下水箱后将其重新插入，并尽量用力往下推。
	萃取机芯变脏/堵塞。	冲洗萃取机芯。
	咖啡机没有放在水平面上。	将咖啡机放在水平表面，防止接水盘溢出，并且“接水盘已满”指示标正常工作。
	水箱未正确安装到位，空气被吸入咖啡机。	请确保水箱处于正确位置：取下水箱后将其重新插入，并尽量用力往下推。
我无法激活 AquaClean 滤水芯，并且咖啡机要求除垢。	AquaClean 过滤芯指示灯开始闪烁后未及时安装或更换滤水芯。这意味着您的咖啡机未完全清除水垢。	请先为咖啡机除垢，再安装 AquaClean 滤水芯。
新的滤水芯无法装入。	您正尝试安装的滤水芯不是 AquaClean 滤水芯。	仅 AquaClean 滤水芯适合此咖啡机。
	AquaClean 滤水芯上的橡胶圈没有放好。	将橡胶圈放回 AquaClean 滤水芯上。
咖啡机发出很大的噪音。	咖啡机在使用过程中发出噪音属于正常现象。	如果咖啡机开始发出另一种噪音，请清洁萃取机芯并为其润滑（请参见“滑润萃取机芯”）。
	AquaClean 滤水芯未妥善准备好，因此现在有空气进入咖啡机。	从水箱中取出 AquaClean 滤水芯并妥善做好使用准备，然后将其放回。请参阅“AquaClean 滤水芯”一章的逐步说明。
	水箱未正确安装到位，空气被吸入咖啡机。	请确保水箱处于正确位置：取下水箱后将其重新插入，并尽量用力往下推。

技术规格

制造商保留改进产品技术规格的权利。所有预设份量均为近似值。

说明

值

尺寸 (宽 x 高 x 深)	246 x 372 x 433 毫米
重量	7-7.5 千克
电源线长度	800-1200 毫米
水箱	1.8 升, 可分离式
咖啡豆仓容量	275 克
咖啡渣盒容量	12 勺
LatteGo (奶缸) 容量	250 毫升
可调节的流出口高度	85-145 毫米
额定电压 - 额定功率 - 电源	请参阅产品背后的铭牌 (图 A10)

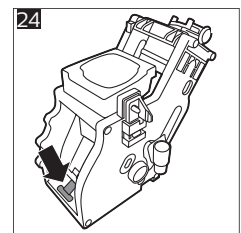
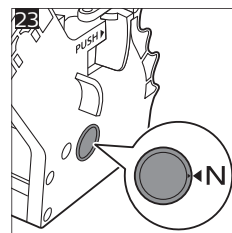
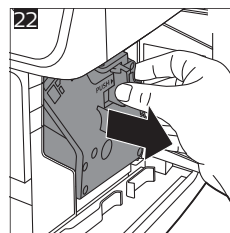
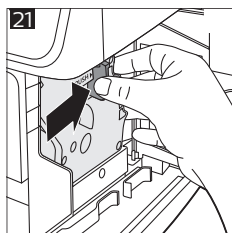
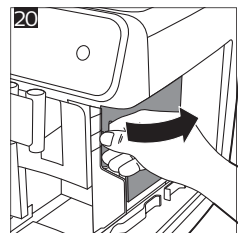
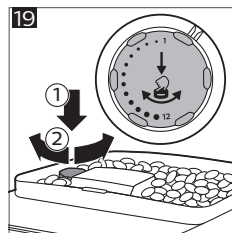
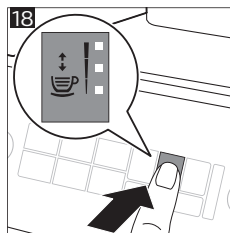
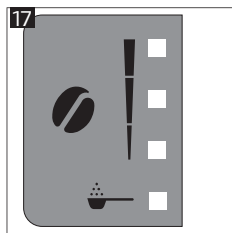
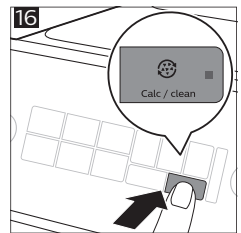
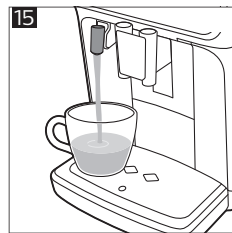
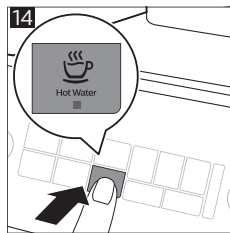
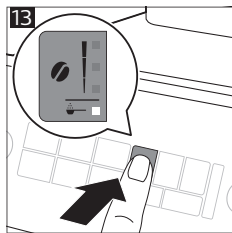
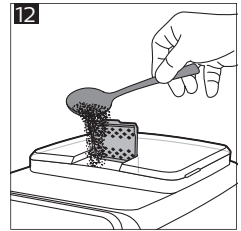
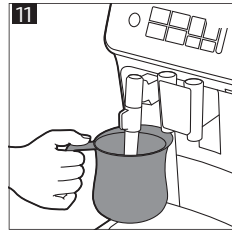
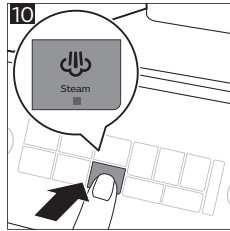
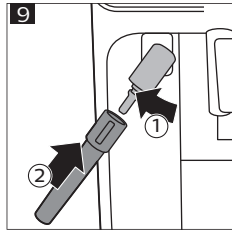
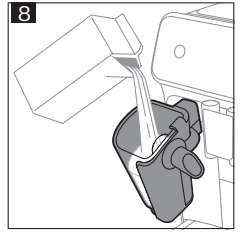
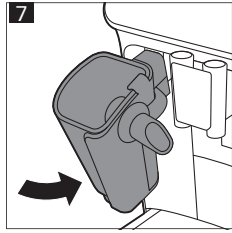
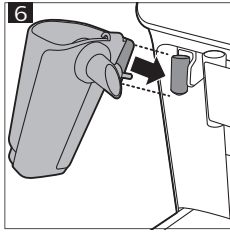
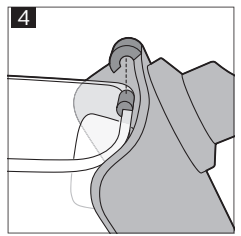
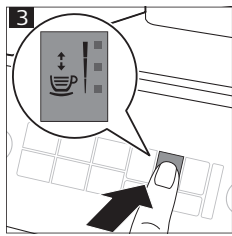
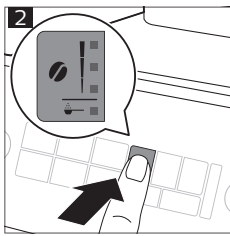
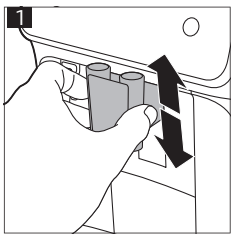

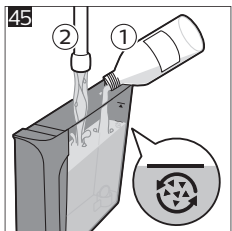
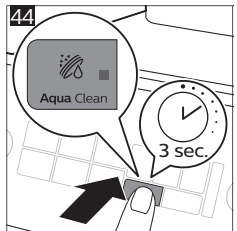
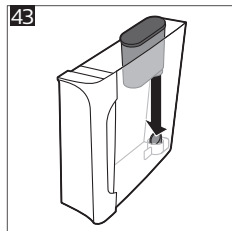
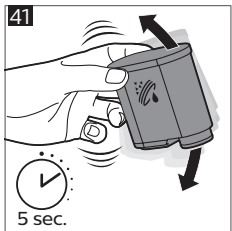
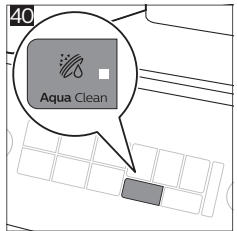
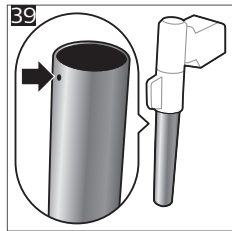
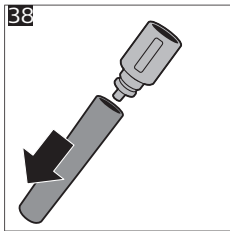
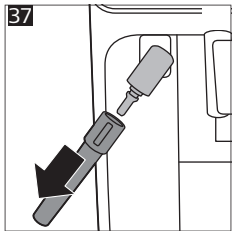
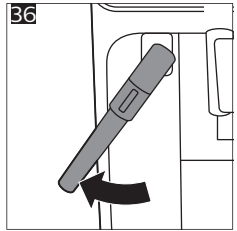
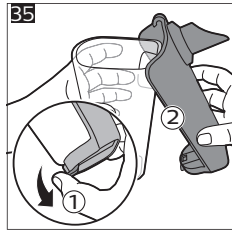
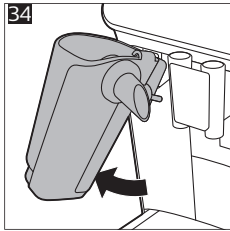
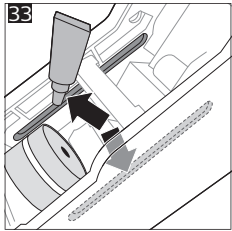
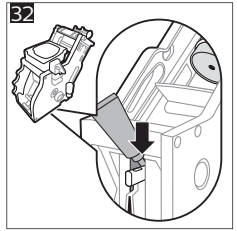
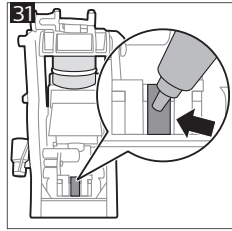
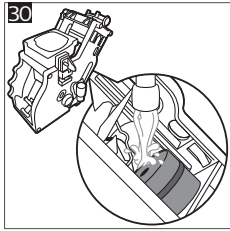
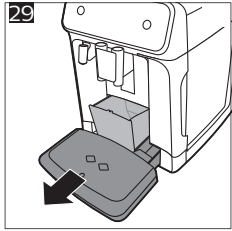
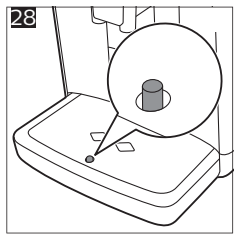
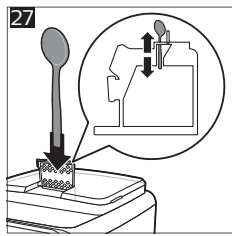
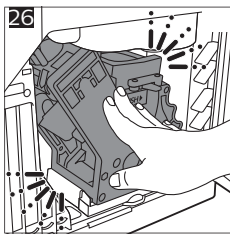
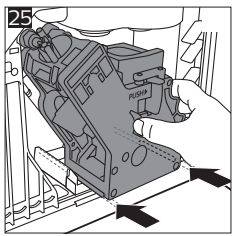

2026 © Versuni Holding B.V.

PHILIPS and the Philips Shield Emblem are registered trademarks of Koninklijke Philips N.V. and are used under license.

This product has been manufactured by and is sold under the responsibility of Versuni Holding B.V., and Versuni Holding B.V. is the warrantor in relation to this product.

PHILIPS 和 Philips 盾徽 是 Koninklijke Philips N.V. 的注册商标，并在许可下使用。

本产品由 Versuni Holding B.V. 制造并负责销售，Versuni Holding B.V. 是本产品的担保人。

642001040457 (04/2026)

